

HDD Series, Crimp Connection, 24 pin, Femle insert

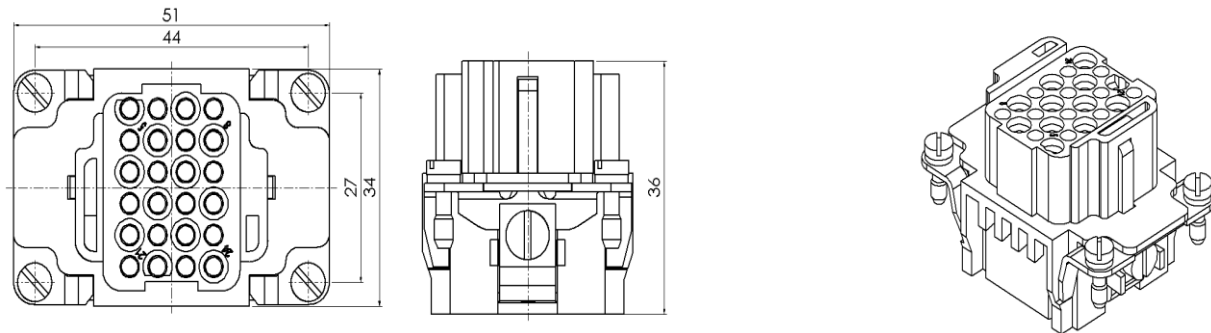

Typecode HDD-024-FC
ID 1 007 03 000084

Technical Data

Product Properties

Series	HDD
Mating with	H6B
Connection mode	Crimp termination
Gender	Femle
Rated voltage	250 V
Rated current	10 A
Rated impulse voltage	4 kV
Mating contact	10A (DSF/DGF)
Number of pins	24
Core cross-section/Clamping ability	0.14~ 2.5 mm ² /AWG26 ~ AWG14
Grounding conductor	Yes
Pollution degree	3
Insulation resistance	≥ 10 ¹⁰ Ω
Limiting temperature	-40 °C ~ +125 °C
Standard	EN 60664-1, IEC 61984

Insert

Material	PC
Colour	RAL 7032

Commercial data

Weight	0.068 kg
Packaging unit	10 pc
Country of origin	CN

Features

- High quality engineering plastics
- Crimp termination
- ≥ 500 Mating cycles
- Approval: CE
- RoHS-compliant

*这里所列的是设计数据，有关产品的变更不在此做说明，未尽事宜请联系客服。用户有责任验证功能、符合适用的法律和指令以及在特定应用中的电气安全。