

M8 A-Coding, Male flange with PCB 90°, rear-mounted

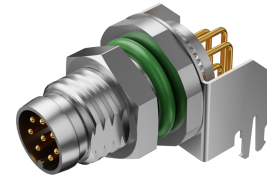
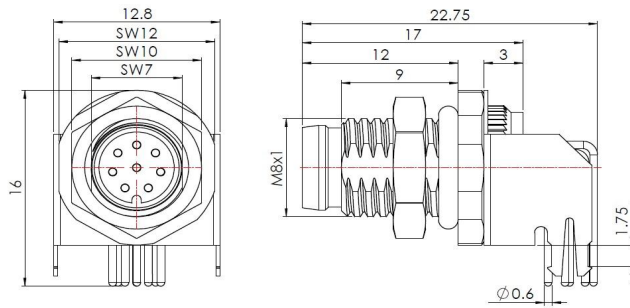

Typcode M08A08MBRB8P9001
ID 1009010000035

Technical Data*

Connector A	
Connector	M8, Male, A-Coding
Number of Pins	6-Pin
Contacts	Brass, Gold-plated
Flange housing	Brass, Nickel-plated
Contact Carriers	PA
Seal	NBR
Protection Class	IP67, Only in screwed condition
Mechanical lifespan	≥ 100 Mating cycles
Pollution degree	III
Locking mode	M8 x 1
Connection mode	PCB 90°
Screw-in thread	M8 x 1
Standard	RoHS

Electrical properties at +20 °C	
Rated Voltage	30 V d.c
Rated current	1.5 A
Test Voltage	800 V
Insulation resistance	≤ 3 mΩ
Contact resistance	≥ 100 MΩ

Mechanical and chemical properties	
Ambient temperature range (stationary)	-40 °C ... 85 °C

Commercial data	
Weight	g
Country of origin	CN
Packaging unit	1 pc

Features

- M8, Male, 6-Pin
- PCB 90°, rear-mounted
- Protection Class: IP67
- RoHS-compliant

Contact assignment

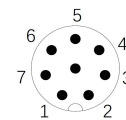

Through bore

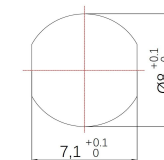

PCB Layout

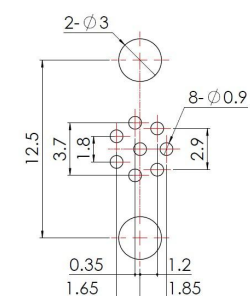

* Please note that the data specified here were design data, and the parameters of product are subject to changes without prior notice. Matters not mentioned herein. Please contact customer service. Please also note that the user is responsible for validating functionality, conformity with applicable laws and directives, as well as for the electrical safety in the particular application.