

Size 24B Sleeve housing, High type, Lateral opening hole

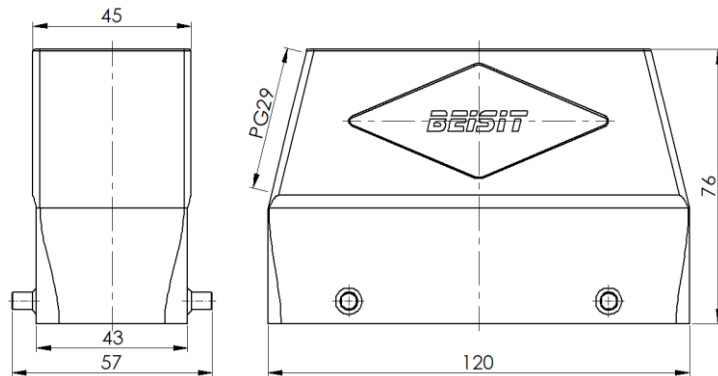

Typecode H24B-SOH-4P-PG29

ID 1 007 01 0000592

Technical Data

Product Properties

Series	Size 24B
Mating with	HE-024, HEE-046, HDD-064, HDD-108, HK-004/8
Housing type	Sleeve housing, high type
Cable outlets direction	Single-side opening
Cable outlets	PG29
Protection Class	IP65
Impact strength	IK08
Temperature range	-40 °C ... 125 °C
Standard	DIN EN 175301-801

Insert

Housing material	Die-cast aluminum
Color	Gray (RAL 7037)

Commercial data

Weight	179 g
Packaging unit	1 pc
Country of origin	CN

Features

- Die casting of aluminum
- Single-side opening
- Resistant to salt spray
- Approval: UL94-V0
- RoHS-compliant

*The design data are listed here, and the changes to the product are not described here. For unfinished matters, please contact customer service. It is the user's responsibility to verify functionality, compliance with applicable laws and instructions, and electrical safety in specific applications.