

## Size 24B Sleeve housing, High type, Lateral opening hole

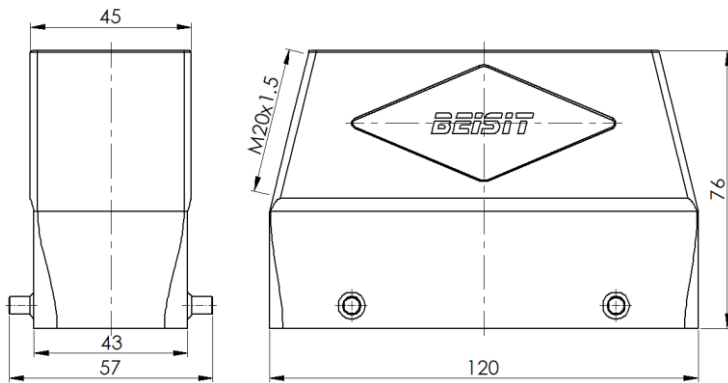

Typecode H24B-SOH-4P-M20

ID 1 007 01 0000586

### Technical Data

#### Product Properties

Series	Size 24B
Mating with	HE-024, HEE-046, HDD-064, HDD-108, HK-004/8
Housing type	Sleeve housing, high type
Cable outlets direction	Single-side opening
Cable outlets	M20 x 1.5
Protection Class	IP65
Impact strength	IK08
Temperature range	-40 °C ... 125 °C
Standard	DIN EN 175301-801

#### Insert

Housing material	Die-cast aluminum
Color	Gray (RAL 7037)

#### Commercial data

Weight	187 g
Packaging unit	1 pc
Country of origin	CN

### Features

- Die casting of aluminum
- Single-side opening
- Resistant to salt spray
- Approval: UL94-V0
- RoHS-compliant

\*The design data are listed here, and the changes to the product are not described here. For unfinished matters, please contact customer service. It is the user's responsibility to verify functionality, compliance with applicable laws and instructions, and electrical safety in specific applications.